

30 Years of Experience on Manufacturing  
Air-Operated Diaphragm Pump for  
Flexographic and Rotogravure Printing Press Machine

30年製造經驗凹凸版印刷機專用氣動雙隔膜泵浦



Ink Circulation &  
Feeding Pump



PT-1/2

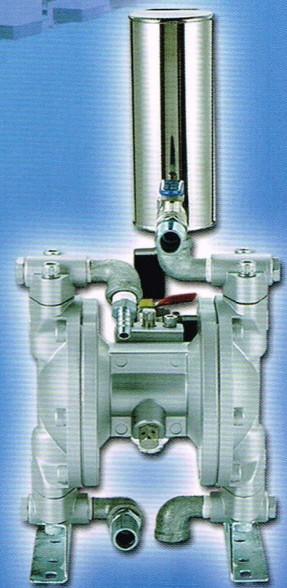

PT-3/8AT



Agitator / 手持式攪拌機



**GAU JIING INDUSTRIAL CO., LTD.**  
高 環 實 業 有 限 公 司

No. 46, 23rd Rd., Taichung Industrial District, Taichung City 40850, Taiwan.  
TEL: 886-4-23502188. 23501908 FAX: 886-4-23502398  
E-Mail: [gaujing@gmail.com](mailto:gaujing@gmail.com) <http://www.yog.com.tw>



# Professional Air-Operated Diaphragm Pump for Rotogravure Printing Press Machine



**PT-3/8A**

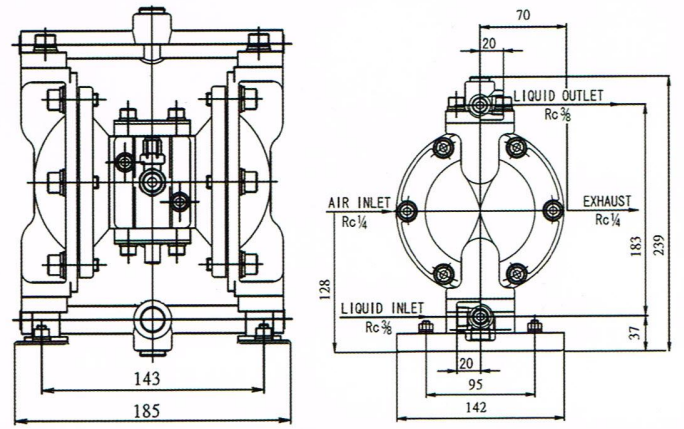
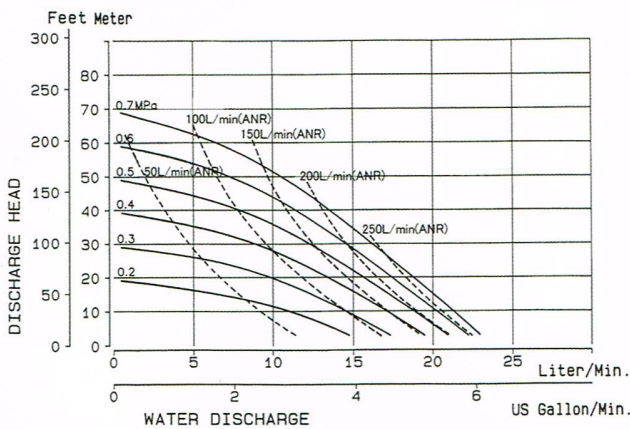

型號/ NO.	本體/ BODY	隔膜片/ DIAPHRAGM MEMBRANE	吸入口/ INLET	吐出口/ OUTLET	空氣入口/ Air Inlet	空氣出口/ Air Outlet	重量/ N.W
PT-3/8A PT-3/8AT	鋁合金 ADC-12	PTFE/Hytrel Santoprene	RC3/8 PT3/8	RC 3/8 PT 3/8	RC1/4 PT 1/4	RC1/4 PT 1/4	4.8 kg

Compression Ratio / 壓縮比: 1:1

Air Supply Pressure / 工作壓力: 0.2mPa~

Discharge Volume Per Cycle / 吞吐量: 50 ml

Maximum Cycle Per Minute / 每分鐘最大循環次數: 300

Maximum Size Solid / 容許粒徑: 1 mm

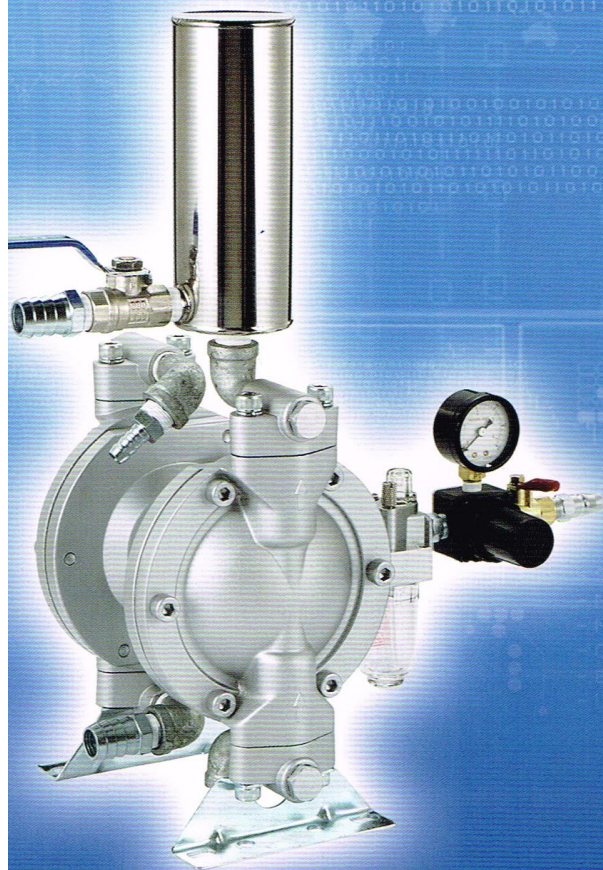

**PT-3/8AT**

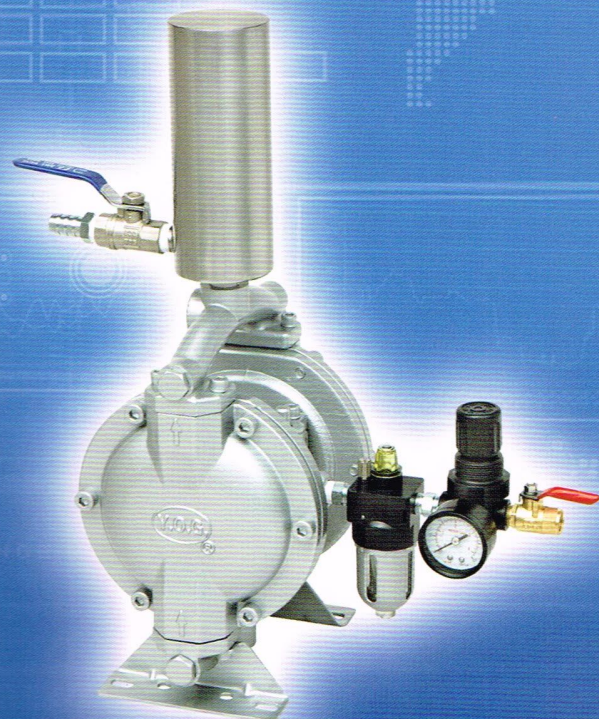

**PT-1/2**

## Internal Parts / 部內零件:

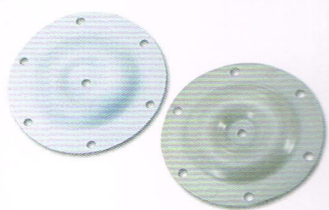

Double Layer Diaphragm: PTFE / Hytrel  
單邊雙層隔膜 (進口高品質半成品)



Graphite Slipper Seal  
超耐磨中心墊圈



SUS 304 Center Rod  
中心軸

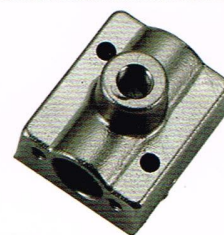

Specialcoating Spool Valve Case  
特殊塗層方向閥

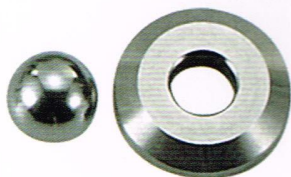

SUS 304 Ball and Seat  
進口高品質不鏽鋼球。閥

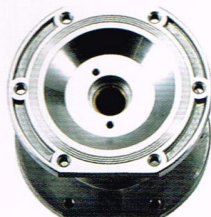

BodyCenter with Leaded Red Brass  
本體中心砲金銅

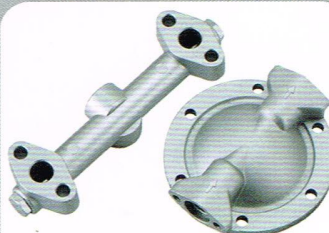

Aluminium Alloy ADC-12  
接液材質

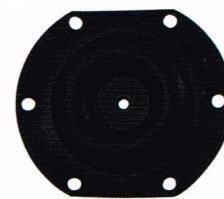

Single Diaphragm: Santoprene  
單邊單層隔膜 (另外選購)

all specification and design are subject to change without notice  
本型錄之機械規格、設計特性，本公司有變更之權力恕不另行通知

# Optional Equipment/ 選購配件:



SUS304 Oneshaped / 一體成型漆桶  
Tank (20L ; 30L)



Aluminum Bentshaped Tube / 鋁彎掛勾

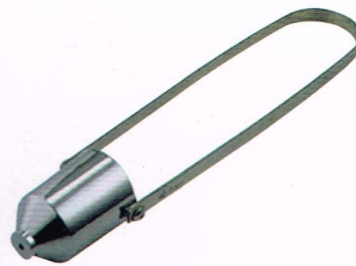

Viscosity Cup No.2 / 黏度杯



Pump Stand Set / 泵浦腳座



NORGREN Regulator / 進口調壓閥

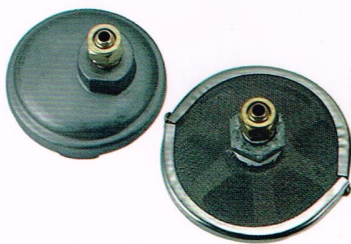

Double Layer Filter /  
One Layer Filter / 鋁合金過濾吸頭



Agitator / 攪拌機



**GAU JIING INDUSTRIAL CO., LTD.**  
高 環 實 業 有 限 公 司

No. 46, 23rd Rd., Taichung Industrial District, Taichung City 40850, Taiwan.  
TEL: 886-4-23502188. 23501908 FAX: 886-4-23502398  
E-Mail: [gaujing@gmail.com](mailto:gaujing@gmail.com) <http://www.yog.com.tw>

